

# INSTALLATION OPERATION AND SERVICE MANUAL MICOFLAME SERIES



## GAS FIRED RESIDENTIAL AND COMMERCIAL COPPER TUBE BOILERS



### FOR HYDRONIC HEATING

*Non-Condensing Models; MFH060, 100, 150, 200, 250, 300, 400, 500, 600*  
*Condensing Models; MFH062, 102, 152, 202, 252, 302, 402, 502, 602*

### HOT WATER SUPPLY

*Non-Condensing Models; MFW060, 100, 150, 200, 250, 300, 400, 500, 600*  
*Condensing Models; MFW062, 102, 152, 202, 252, 302, 402, 502, 602*

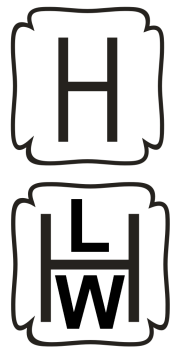

**WARNING:** If the information in these instructions is not followed exactly, a fire or explosion may result causing property damage, personal injury or death

- Do not store or use gasoline or other flammable vapours and liquids in the vicinity of this or any other appliance.
- **WHAT TO DO IF YOU SMELL GAS**
  - Do not try to light any appliance,
  - Do not touch any electrical switch; do not use any phone in your building,
  - Immediately call your gas supplier from a neighbour's phone. Follow the gas supplier's instructions,
  - If you cannot reach your gas supplier, call the fire department.
- Qualified installer, service agency or the gas supplier must perform installation and service.

To the installer: After installation, these instructions must be given to the end user or left on or near the heater.  
To the End User: This booklet contains important information about this heater. Retain for future reference.

## **CAMUS HYDRONICS LTD.**

6226 Netherhart Road, Mississauga, Ontario, L5T 1B7

# Table of Contents

INTRODUCTION .....	2
1. GENERAL INSTRUCTIONS .....	2
2. BOILER LOCATION .....	3
3. PROVIDE AIR FOR COMBUSTION AND VENTILATION .....	4
4. ELECTRICAL WIRING .....	5
5. NORMAL GAS SUPPLY AND PIPING .....	5
6. VENTING .....	6
6.1 OUTDOOR VENTING .....	9
6.2 SIDEWALL VENTING .....	9
6.3 OUTDOOR AIR KIT .....	9
6.4 FILTER KIT .....	10
6.5 STANDARD VENTING .....	10
6.6 VENTING FOR CONDENSING APPLICATION .....	10
7. ACCESSORIES .....	12
8. FREEZE PROTECTION .....	13
9. WARNING REGARDING CHILLED WATER SYSTEMS .....	13
10. PIPING OF BOILER TO SYSTEM (FIG.4) .....	14
11. PLACING BOILER IN OPERATION .....	15
12. MICOFLAME CONTROL PANEL .....	16
12.1 GENERAL SYMBOL DESCRIPTION .....	17
12.2 MODE 1 & 2: SETPOINT OPERATION: VIEW DISPLAY .....	18
12.3 MODE 1 & 2: SETPOINT OPERATION: ADJUST DISPLAY .....	19
12.4 MODE 3: SETPOINT OPERATION: VIEW DISPLAY .....	20
12.5 MODE 3: SETPOINT OPERATION: ADJUST DISPLAY .....	21
12.6 MODE 4 & 5: OUTDOOR RESET OPERATION: VIEW DISPLAY .....	22
12.7 MODE 4 & 5: OUTDOOR RESET OPERATION: ADJUST DISPLAY .....	23
12.8 MODE 6: OUTDOOR RESET OPERATION: VIEW DISPLAY .....	25
12.9 MODE 6: OUTDOOR RESET OPERATION: ADJUST DISPLAY .....	26
13. IGNITION SYSTEM SAFETY SHUT-OFF DEVICE .....	26
14. LOW WATER TEMPERATURE SYSTEMS .....	26
15. INSTANTANEOUS WATER HEATER .....	27
16. CONDENSING HEAT RECOVERY MODULE .....	28
17. PILOT AND MAIN BURNER FLAMES .....	30
17.1. MAIN BURNER .....	30
17.2 REMOVAL OF COMBUSTION CHAMBER LINING .....	31
17.3 PILOT BURNER .....	32
18. OPERATION AND SERVICE .....	33
19. LIGHTING INSTRUCTIONS .....	34
20. TROUBLE SHOOTING GUIDE .....	35
21. TYPICAL GAS TRAIN .....	36
22. ELECTRICAL DIAGRAMS .....	36
23. EXPLODED VIEW .....	38
24. MICO FLAME REPLACEMENT PARTS LIST .....	39
WARRANTY .....	40

## **INTRODUCTION**

Camus Hydronics proudly introduces its MicoFlame series of water heaters / hydronic boilers. These gas burning appliances are thoughtfully designed for easy operation and maintenance. We are confident that you will come to appreciate the benefits of our product.

### **1. GENERAL INSTRUCTIONS**

The installation of this heater must conform to the requirements of the authority having jurisdiction or, in the absence of such requirements, to the latest or current as amended National Fuel Gas Code, ANSI Z223.1 or CAN/CGA B149 Installation Codes. All electrical wiring must be done in accordance with the requirements of the authority having jurisdiction or, in the absence of such requirements, with the National Electrical Code, ANSI/NFPA 70 or the Canadian Electrical Code Part I, CSA C22.1 Electrical Code.

Vent installations must be in accordance with Part 7, Venting of Equipment, of the latest edition or the current as amended National Fuel Gas Code, ANSI Z223.1, or Section 7, Venting Systems and Air Supply for Appliances, of the CAN. CGA B149, Installation Codes and applicable provisions of the local building codes.

When required by the authority having jurisdiction, the installation must conform to the Standard for Controls and Safety Devices for Automatically Fired Boilers, ANSI/ASME CSD-1.

The qualified installer shall instruct the end user in the safe and correct operation of this appliance and shall ensure that the heater is in safe working order prior to leaving the job site.

#### **WARRANTY:**

**Factory warranty shall apply only when the boiler is installed in accordance with local plumbing and building codes, ordinances and regulations, the printed instructions provided with it and good industry practices.**

**Excessive water hardness causing a lime build-up in the copper coils or tubes is not a fault of the boiler. Consult the factory for recommendations for use in hard water areas. Damage to the heat exchanger as a result of scaling or corrosive water conditions in non-warrantable.**

**Using or storing corrosive chemicals in the vicinity of this boiler can rapidly attack the copper tubes and coils and voids warranty.**

**The primary heat exchanger of this boiler is intended to operate under non-condensing conditions. Inlet temperatures must be maintained at 110 °F or higher. Warranty is void if the primary heat exchanger is allowed to operate in condensing mode.**

**Damage caused by freezing or dry firing voids warranty.**

**This boiler is not to be used for temporary heating of buildings under construction.**

## 2. BOILER LOCATION

Install this boiler in a clean, dry location with adequate air supply and close to a good vent connection. Do not locate this boiler in an area where it will be subject to freezing.

The boiler is suitable for installation on combustible flooring and should be located close to a floor drain in an area where leakage from the boiler or connections will not result in damage to the adjacent area or to lower floors in the structure. If necessary a suitable drain pan should be installed under the boiler.

If the boiler is installed above the level of the building's radiation system, a low water cutoff device must be installed in the boiler outlet at the time of installation. Some local codes require the installation of a low water cutoff on all systems. Locate the boiler so as to provide adequate clearance for inspection and service all around the unit. It is recommended that 24" be provided for the top and sides and 48" for the front. This boiler is suitable for alcove installation with minimum clearances to combustibles as follows:

TOP:	12"
SIDES:	12"
REAR:	12"
VENT:	6"
FLOOR:	0"

For boiler's dimensions see Figure 1 and table 1

### Model 60 - 300

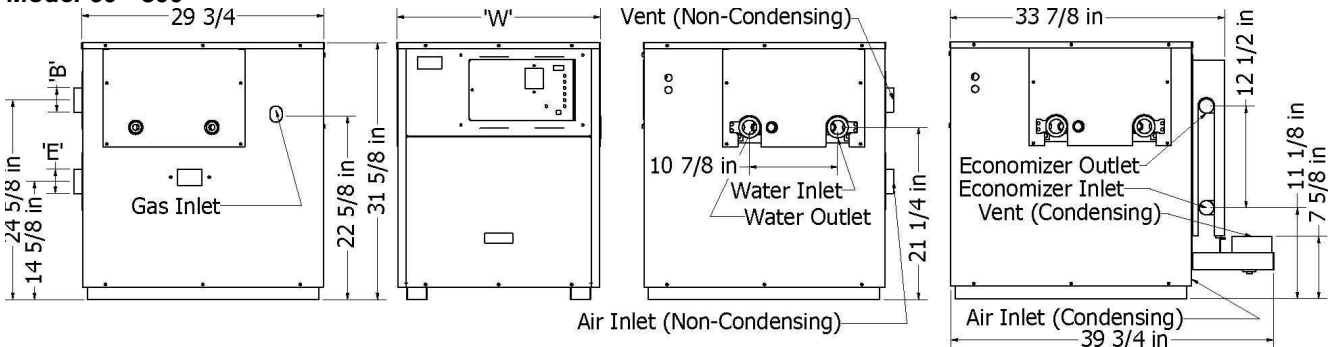

### Model 400 - 600

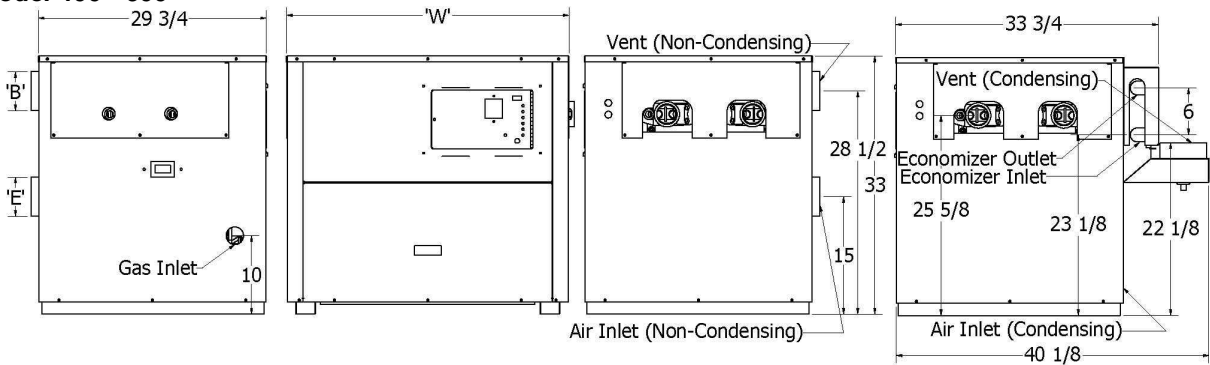

Side View (Left)

Front View

Side View (Right)

Side View (Right) Condensing

Figure 1

Table 1

Model	'W'	Water Connection	Gas Connection	B' Dia. Venting*			E' Dia. Air Inlet
				Outdoor	Sidewall or Condensing	Standard	
MFNH060	18 3/4	1 1/2	1/2	3	3	3	3
MFNH100	18 3/4	1 1/2	1/2	3	3	4	3
MFNH150	18 3/4	1 1/2	1/2	3	3	4	3
MFNH200	18 3/4	1 1/2	1/2	4	4	5	4
MFNH250	25	1 1/2	3/4	4	4	5	4
MFNH300	25	1 1/2	3/4	5	5	6	5
MFNH400	31 1/2	2	1	5	5	6	5
MFNH500	31 1/2	2	1	6	6	7	6
MFNH600	36 1/2	2	1	6	6	7	6

\* Non-condensing models are shipped with standard vent opening size unless sidewall vent is specified

### 3. PROVIDE AIR FOR COMBUSTION AND VENTILATION

Provisions for combustion and ventilation air must be in accordance with:

- Section 5.3. Air for combustion and Ventilation, of the latest or current as amended National Fuel Gas Code, ANSI Z223.1, or;
- Sections 7.2, 7.3 or 7.4 of CAN/CGA B149 Installation Codes, and;
- Applicable provisions of the local building codes.

The operation of exhaust fans, compressors, air handling units etc. can rob air from the room, creating a negative pressure condition leading to reversal of the natural draft action of the venting system. Under these circumstances an engineered air supply is necessary.

If the heater is to be installed near a corrosive or potentially corrosive air supply, the heater must be isolated from it and outside air should be supplied as per code.

Potentially corrosive atmospheres will result from exposure to permanent wave solution, chlorinated waxes and cleaners, chlorine, water softening chemicals, carbon tetrachloride, halogen based refrigerants, Freon cleaning solvents, hydrochloric acid, cements and glues, masonry washing materials, antistatic fabric softeners, dry cleaning solvents, degreasing liquids, printing inks, paint removers, etc.

#### 4. ELECTRICAL WIRING

All electrical wiring to the boiler must be electrically bonded to ground in accordance with the requirements of the authority having jurisdiction or, in the absence of such requirements, with the National Electrical Code, ANSI/NFPA 70 or the Canadian Electrical Code Part I, CSA C22.1, Electrical Code.

Provide disconnecting means of sufficient rating within sight of the boiler. These heaters require an 115V, 60Hz supply. Depending on the pump used, a 15-amp breaker is usually sufficient.

Electrical connections must be made so that the circulator will operate before the gas valve can open. At no time may the control system allow the burner to fire without water flowing in the system.

Use minimum 18-gauge conductor for 24-volt field wiring to boiler. Splicing of wires is not recommended.

Use sealed tight conduit suitable for outdoor use for outdoor installations.

Use terminal strip provided inside control panel for low water cut-off and remote controller

Refer to wiring diagram provided with boiler.

#### 5. NORMAL GAS SUPPLY AND PIPING

This boiler is intended to operate at inlet gas pressures not exceeding 1/4 PSI (7"W.C.) when firing with natural gas. If higher pressures are present, consult the gas company for correction.

When pressure testing the gas supply piping at pressures above 1/2 PSI, the boiler and its individual gas shut-off valve must be disconnected from the supply piping.

Provide a trap (drip leg) as close to the heater as possible.

Install a ground joint union and manual shut-off valve in the gas line near the heater to allow easy removal of the gas control assembly.

Provide gas pressures at inlet to appliance in accordance with the limits in the table below:

	PROPANE	NATURAL GAS
Minimum Running (inches W.C.)	10	4
Maximum Lockup (inches W.C.)	11	14

The gas supply line must be of adequate size to prevent undue pressure drop and must never be smaller than the size of the connection on the heater. Sizing based on Table 2 is recommended.

Before operating the boiler, the complete gas train and all connections must be tested using soap solution.

**Table 2**

DISTANCE FROM NATURAL GAS METER OR PROPANE SECOND STAGE REGULATOR						
Input Btu/Hr	0-100 FT		100-200 FT.		200-300 FT.	
	NAT.	L.P.	NAT.	L.P.	NAT.	L.P.
60,000	3/4"	1/2"	3/4"	1/2"	1"	3/4"
100,000	3/4"	1/2"	1"	3/4"	1"	3/4"
150,000	1"	3/4"	1 1/4"	1"	1 1/4"	1"
200,000	1"	3/4"	1 1/4"	1"	1 1/4"	1"
250,000	1 1/4"	1"	1 1/4"	1"	1 1/2"	1 1/4"
300,000	1 1/4"	1"	1 1/2"	1 1/4"	1 1/2"	1 1/4"
400,000	1 1/4"	1"	1 1/2"	1 1/4"	2"	1 1/2"
500,000	1 1/2"	1 1/4"	2"	1 1/2"	2"	1 1/2"
600,000	1 1/2"	1 1/4"	2"	1 1/2"	2"	1 1/2"

## 6. VENTING

Boilers for outdoor installation are intended to vent using a listed vent cap.

For indoor installations venting must be in accordance with Part 7, Venting of Equipment, of the latest or current as amended National Fuel Gas Code, ANSI Z223.1, or Section 7, Venting of Equipment and Air Supply for Appliances, of the CAN/CGA B149, Installation Codes, and applicable provisions of the local building codes.

Vent connectors serving appliances vented by natural draft shall not be connected into any portion of mechanical draft systems operating under positive pressure.

Horizontal runs of vent pipe shall be securely supported (approximately every 4 feet) to prevent sagging and maintain a minimum upward slope of 1/4" per foot from the boiler to the vent terminal.

When an existing boiler is removed from a common venting system, the common venting system is likely to be too large for proper venting of the appliances remaining connected to it. At the time of removal of an existing boiler, the following steps must be followed with each appliance remaining connected to the common venting system placed in operation, while the other appliances remaining connected to the common venting system are not in operation.

- a) Seal any unused openings in the common venting system.
- b) Visually inspect the venting system for proper size and horizontal pitch and determine that there is no blockage, restriction, leakage, corrosion or other deficiency, which could cause an unsafe condition.
- c) Insofar as is practical, close all building doors and windows and all doors between the space in which the appliances remaining connected to the common venting system are located and other spaces of the building. Turn on the clothes dryers and any appliances not connected to the common venting system. Turn on any exhaust fans, such as range hoods and bathroom exhausts,

so they will operate at maximum speed, do not operate a summer exhaust fan. Close fireplace dampers.

- d) Place in operation the appliance being inspected. Follow the lighting instructions. Adjust thermostat so that appliance operates continuously.
- e) Test for spillage at the draft control device relief opening after 5 minutes of main burner operation. Use the flame of a match or candle or smoke from a cigarette.
- f) After it has been determined that each appliance remaining connected to the common venting system properly vents when tested as outlined above, return doors, windows, exhaust fans, fireplace dampers and any other gas-burning appliance to their previous condition of use.
- g) Any improper operation of the common venting system must be corrected so that the installation conforms to the National Fuel Gas Code, ANSI Z223.1 or CAN/CGA B149, Installation Codes. When resizing any portion of the common venting system, the common venting system should be resized to approach the minimum size as determined using the appropriate tables in Part 11 of the latest or current as amended National Fuel Gas Code, ANSI Z223, 1 or CAN/CGA B149, Installation Codes.

Heat exchanger surfaces and vent piping should be checked every six months for deterioration and carbon deposits. Remove all soot or other obstructions from the chimney and flue, which might impede draft action. Replace any damaged or deteriorated parts of the venting system.

A qualified service technician should follow this procedure when inspecting and cleaning the heat exchanger and vent pipe.

1. Turn off electrical power and close main manual gas shut-off and allow boiler to cool down
2. Remove the vent pipe running to chimney. Remove top outer panel and flue collector access panel. Check heat exchanger, vent and chimney for obstruction and clean as necessary.
3. Remove burner from boiler and vacuum the burner, and the heat exchanger. If heat exchanger is excessively dirty it may be necessary to remove it from the boiler and wash it down with proper detergent cleaner. Be aware that the combustion chamber base is insulated with ¼" thick ceramic paper. If this material is damaged or displaced it must be replaced before starting up the boiler.
4. Reinstall parts removed in steps 2 and 3. Be sure that vent pipe has proper pitch and is properly sealed. Repair or replace any gaskets, which may have been damaged in steps 2 and 3.

5. **CAUTION:** When replacing the burner be careful to fully engage the back of the burner box into the retaining slot in the combustion chamber base. Failure to properly locate the burner will result in erratic flame operation with the possibility of delayed ignition on light off.
6. Restore electrical power and gas supply to boiler.
7. Place boiler in operation using lighting instructions provided.
8. While the boiler is operating, check for flue gas leaks and proper vent operation. Seal any flue gas leaks using appropriate gasket or sealing material. Carefully examine the flue collector access panel and heat exchanger ends.

The MicoFlame is a category 1, 85% efficient when supplied as a non-condensing appliance. When supplied with the optional condensing cartridge, the MicoFlame is 95% efficient and is considered to be a category II or IV appliance. Three venting options are available for this boiler. See Figure 2 for details. (Please refer to Table 1 for vent dimensions)

**Figure 2**

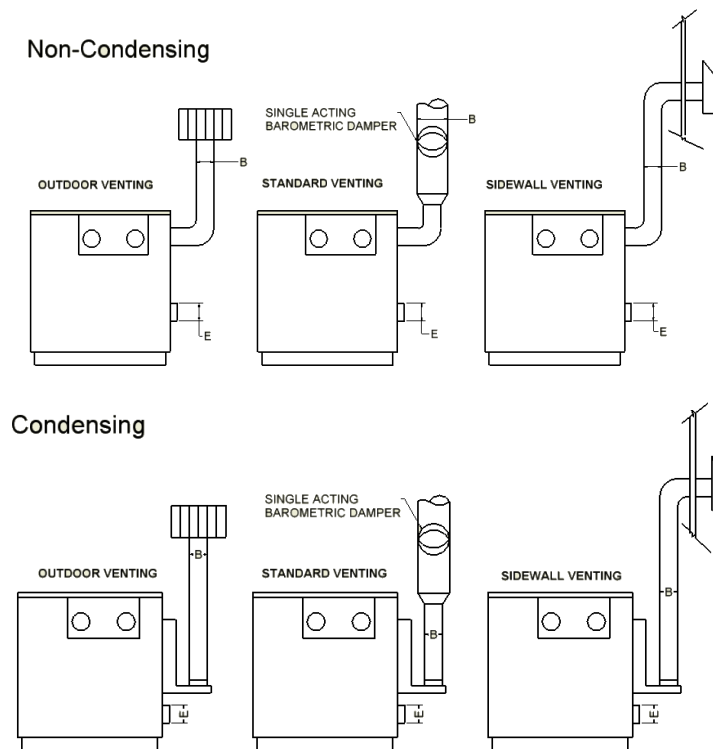

## **6.1 OUTDOOR VENTING**

When fitted with the factory supplied rain shield and UL approved vent cap, the MicoFlame is self-venting. The following applies to outdoor installations:

1. Use only factory supplied rain shields.
2. Periodically check to ensure that air intake and vent cap are not obstructed.
3. Locate boiler at least 3 feet away from any overhang.
4. Locate boiler at least ten feet from building air intake.
5. Avoid installation in areas where runoff from adjacent building can spill onto boiler.

## **6.2 SIDEWALL VENTING**

When fitted with the factory supplied vent terminal, the MicoFlame can vent up to 50 equivalent feet. Elbows can range from 5 to 9 feet in equivalent length depending on centerline radius. See Table 1 for vent sizes.

Boilers may be installed with either a horizontal sidewall vent or vertical roof top terminal. Terminals differ with each application. Horizontal lengths over 5 feet must be installed using corrosion resistant stainless steel. Use single wall vent and seal all joints or use pressure rated double wall vent.

Refer to local codes for proper installation and location of vent terminals.

When using sidewall vent, all vent connector seams and joints must be sealed with pressure sensitive aluminium tape or silicone sealant as specified by the vent manufacturer. Aluminum tape must meet the provisions of SMACNA AFTS-100-73 Standard.

When venting through unheated spaces with single wall vent, insulation should be wrapped around the vent pipe to prevent flue gas condensation inside the vent.

Periodically check to ensure that the vent terminal is unobstructed.

## **6.3 OUTDOOR AIR KIT**

When fitted with the factory supplied air inlet ring and air intake terminal, the MicoFlame can draw outdoor air over an equivalent length of 50 feet. See Table 1 for vent sizes.

Boilers may be installed with either a horizontal sidewall vent or vertical roof top terminal. Terminals differ with each application.

The following applies to outdoor air installations:

1. Use only factory supplied air intake terminal.
2. Periodically check to ensure that air intake is not obstructed.
3. Refer to local codes for proper installation and location of vent terminals. Vertical vent terminal must be at least 3 feet above the highest point where it is located above the roof of a building and at least two feet higher than any part of the building within a horizontal distance of ten feet
4. Locate the air intake five feet away from the vent discharge. For sidewall venting locate the air intake below the vent outlet if possible.

#### **6.4 FILTER KIT**

A louvered rear panel is the standard air inlet configuration for the MicoFlame. A filter kit is available. The filter is washable and accounts for an additional pressure loss of less than 0.05" W.C. Highly recommended for dusty environments.

The filter kit can also be provided when using the outdoor air kit.

#### **6.5 STANDARD VENTING**

The MicoFlame is a category 1 appliance and is approved for venting into a common standard chimney. If chimney height is much greater than 30 feet or if drafts are excessive, it may be preferable to provide a single acting barometric damper directly above the vent collar. This damper will ensure smooth light off and minimize standby loss through the boiler. Be sure to position the damper at least 6 "away from the wall of the vent connector.

#### **6.6 VENTING FOR CONDENSING APPLICATION**

When supplied with the optional condensing cartridge, the MicoFlame is 95% efficient (category II or IV appliance) which requires the use of a special venting system fabricated from AL29-4C or equivalent material. Only venting components listed by a nationally recognized testing agency may be used.

This appliance may be installed with conventional, sidewall or vertical venting. Conventional vented appliances operate with negative pressure in the vent pipe and require a special vent adapter to increase the flue outlet diameter. Sidewall and vertically vented appliances operate with positive pressure in the vent pipe and may be directly connected to the flue outlet without the use of an increaser.

Consult the vent pipe manufacturer's instructions for minimum clearances to combustible material for vent components. In the absence of instructions, the minimum clearance to combustible material is six inches.

Consult vent pipe manufacturer's instructions for proper method of sealing vent pipe sections and fittings. In the absence of instructions, make sure that pipe and fittings are clean by swabbing with alcohol. Use Dow Corning 736 or 732 RTV, Polybar # 500 RTV or Sil-bond 4500 or 6500 to seal vent pipe. Do not use other sealants or adhesives except as expressly permitted by vent manufacturer's instructions.

Consult vent pipe manufacturer's instructions for vent system assembly. Follow vent pipe manufacturer's instructions if those instructions differ from this section.

### **Conventional Venting**

Multiple appliances may be vented into a conventional chimney. The chimney must be lined with AL29-4C and a single acting barometric damper must be provided for each appliance. Vent diameters are to be increased by one size over the recommended size

A qualified professional using a proven vent-sizing program with input of accurate operating parameters must properly calculate sizing of the venting system. In applications where flue gas temperatures are lower than can support a Category II with conventional negative draft, it will be determined at the venting design stage that a positive pressure will be developed in the vent. It will then be necessary to either provide separate vents as for Category IV, or to provide an extractor at the chimney outlet in order to maintain a negative draft in the chimney and allow common venting.

Approval of the installation will be at the discretion of authorities having jurisdiction.

The chimney must be protected from down drafts, rain and debris by using a listed chimney cap.

### **Sidewall and Vertical Venting**

The maximum vent length is 50 equivalent feet. Vent pipe may be run through a vertical or horizontal chase provided that minimum clearances to combustible materials are maintained.

The vent termination location is restricted as follows:

Minimum 12 inches above grade plus normally expected snow accumulation. Or 7 feet above grade if located adjacent to public walkways. Do not install over public walkway where local experience indicates condensation or vapor from the boiler creates a nuisance or hazard. Minimum 3 feet above any forced air inlet located within 10 feet of vent termination. Minimum 4 feet below, 4 feet horizontally or above any door window or gravity air inlet. Minimum 4 feet horizontally from electric meters, gas meters, regulators and relief valves. Use appropriately designed thimbles when passing through combustible walls or roofs. Install fire stops where vent passes through floors, ceilings or framed walls. The fire stop must close the opening between the vent pipe and the structure. Locate vent terminal above combustion air intake terminal (if used) and no closer than 2 feet vertically or horizontally. Vertical venting requires flashing and a storm collar to prevent moisture from entering the structure. Vertical vent termination must be at least 2 feet plus the expected snow accumulation above the roof penetration height.

## 7. ACCESSORIES

### WATER FLOW SWITCH (shipped loose)

A water flow switch is shipped loose and is to be installed in the outlet piping on all heating boilers and hot water supply boilers. The flow switch is wired in series with the 24VAC safety control circuit. A diagnostic light will be indicated on the control display on a low flow condition.

### LOW WATER CUTOFF (If Equipped)

If this boiler is installed above radiation level, a low water cut-off device must be installed at the time of boiler installation. Some local codes require the installation of a low water cut-off on all systems. Electronic low water cut-offs are available as a factory supplied option on all models. Low water cut-offs should be tested every six months. The normally open switch contact of the low water cutoff is to be wired in series with the flow switch. A diagnostic light will be indicated on the control display on a low flow condition. Caution: remove jumper when connecting to 24 VAC circuit.

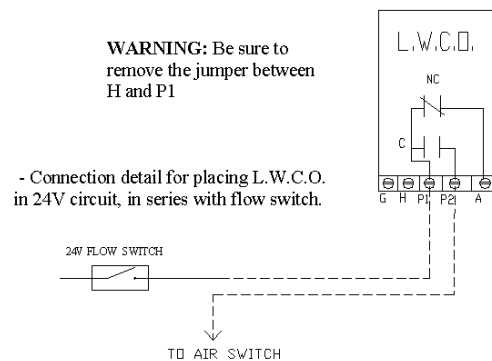

### RELIEF VALVE (shipped loose)

This appliance is supplied with a relief valve sized in accordance with ASME Boiler and Pressure Vessel Code, Section IV (“Heating Boilers”). The relief valve is to be installed in the vertical position and mounted in the hot water outlet. No valve is to be placed between the relief valve, and the appliance. To prevent water damage, the discharge from the relief valve shall be piped to a suitable floor drain for disposal when relief occurs. No reducing couplings or other restrictions shall be installed in the discharge line. The discharge line shall allow complete drainage of the valve and line. Relief valves should be manually operated at least once a year.

### CONDENSING HEAT RECOVERY MODULE PIPING CONFIGURATIONS

Caution: If isolation valves are provided on the CHRM, the provision of a relief valve at the outlet of the secondary is recommended. This valve is to be sized at minimum for 10% of the input of the appliance and is to be piped to drain in a manner similar to the appliance relief valve.

### CHRM IN SERIES WITH PRIMARY HEAT EXCHANGER (INTEGRATED LOOP)

The supply water (Cold water) is pre-heated by CHRM and fed into the outlet of the primary Heat Exchanger. Provisions must be made to prevent cold water below 115°F (46°C) entering the Primary Heat Exchanger.

### **BOILER APPLICATION (HYDRONIC HEATING)**

In case of boiler (Hydronic heating boiler) application, the return water (supply water) may be more than 115°F (46°C), therefore there is no need for a recirculation loop and the primary heat exchanger and CHRMs can be piped in parallel. Since the inlet water temperature to CHRMs exceeds 115°F (46°C) it will not condense fully and therefore the CHRMs will not perform to its maximum efficiency capacity. If water colder than 115°F (46°C) is available it can be fed to the CHRMs.

### **WATER HEATER APPLICATION (HOT WATER SUPPLY)**

In case of domestic water supply (Water Heating), the fresh inlet water temperature will be less than 115°F (46°C), in this case the CHRMs may be fed directly with part of the supply water using a secondary pump.

## **8. FREEZE PROTECTION**

- Appliance installations are not recommended outdoors in areas where danger of freezing exists unless precautions are taken. Maintaining a mixture of 50% water and 50% propylene glycol is the preferred method of freeze protection in hydronic systems. This mixture will protect the appliance to approximately -35°F (-37°C). To maintain the same temperature rise across the appliance increase the GPM flow by 15% and the head loss by 20%.

The following example demonstrates the procedure to follow for calculating the revised head for the heat exchanger when using a water / glycol mixture.

- Given that Camus is showing a heat exchanger flow and head loss of 100 gpm @ 10 feet
- Increasing the flow by 15% now results in a head loss of 13 feet at 115 gpm (from B&G system syzer). At this increased flow Camus now recommends to increase the head loss by 20%.
- The requirement for the heat exchanger with water / glycol mixture will now be 115 gpm @ 15.6 feet. (ie.  $1.2 \times 13\text{ft.} = 15.6\text{ ft.}$ )
- A similar procedure must be followed to calculate the additional head loss in pipe and fittings in order to arrive at the proper pump selection.
- For Outdoor installations a snow screen should be installed to prevent snow and ice accumulation around the appliance. Regular inspections should be made to ensure that air intake and vent are free of snow and ice. Always consider the use of a shelter such as a garden shed in lieu of direct exposure of the appliance to the elements. The additional protection afforded by the shelter will help to minimize nuisance problems with electrical connections and will allow easier servicing of the appliance under severe weather conditions.

## **9. WARNING REGARDING CHILLED WATER SYSTEMS**

When a boiler is connected to an air conditioning system where the same water is used for heating and cooling, the chiller must be piped in parallel with the boiler. Appropriate flow control valves; manual or motorized must be provided to prevent the chilled water from entering the boiler. (See Figure 3)

**Figure 3**

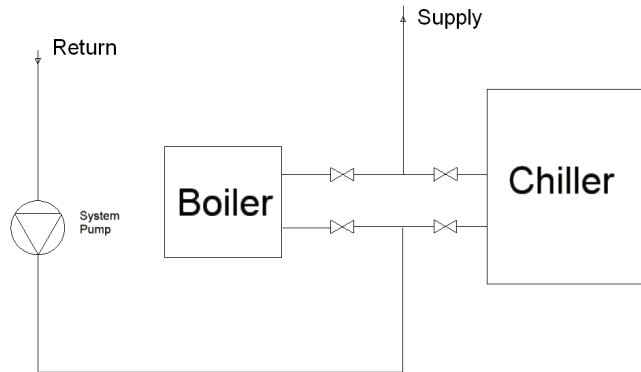

When a boiler is connected to heating coils located in air handling units (where they may be exposed to refrigerated air circulation), the boiler piping system shall be equipped with a flow control valve or other automatic means to prevent gravity circulation of chilled water through the boiler. Chilled water in the boiler will create condensate on the boiler tubes, which will collect in the combustion chamber causing corrosion.

**10. PIPING OF BOILER TO SYSTEM (FIG.4)**

Check all applicable local heating, plumbing and building safety codes before proceeding.

Be sure to provide unions and gate valves at inlet and outlet to boiler so that it can be easily isolated for service.

This boiler is of a low mass design, which provides for instant heat transfer. Special attention to water flow rates will ensure that temperature rise does not exceed 35°F (19.4°C). The following Table 3 is provided as a guide.

For application in areas known to have hard water conditions, contact factory for recommendations.

**Table 3**

***Head Loss and Flow Vs Temperature Rise***

Model	10 °F		20 °F		30 °F	
	USGPM	ΔP ft.	USGPM	ΔP ft.	USGPM	ΔP ft.
60	10.2	0.03	5.1	0.01	3.4	0.005
100	17.0	0.07	8.5	0.02	5.7	0.010
150	25.5	0.20	12.8	0.04	8.5	0.030
200	34.0	0.40	17.0	0.08	11.3	0.050
250	42.5	0.65	21.3	0.16	14.2	0.100
300	51.0	1.50	25.5	0.49	17.0	0.190
400	68.0	2.00	34.0	0.55	22.7	0.260
500	85.0	3.00	42.5	0.76	28.3	0.390
600	102.0	4.30	51.0	1.15	34.0	0.550

**Figure 4**

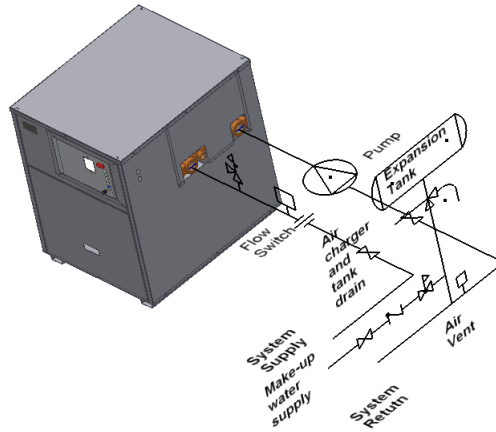

If the boiler is installed above radiation level, it must be provided with a low water cutoff device at the time of boiler installation. (Available from factory)

To eliminate trapped air, install venting devices at high points in the system as well as in the piping on the suction of the pump and in the piping on the discharge of the boiler.

Suitable pipe hangers must support the weight of all water and gas piping or floor stands.

Do not allow the boiler to run with inlet water temperature below 115°F (46 °C).

The boiler must be installed so that the gas ignition system components are protected from water (dripping, spraying, rain, etc.) During appliance operation and service (circulator replacement, control replacement, etc.)

## **11. PLACING BOILER IN OPERATION**

The MicoFlame boiler should be installed and started up by qualified personnel.

With the boiler off, open makeup water valve and allow system to fill slowly. Adjust the pressure regulator to provide at least 15 PSIG in the system when cold.

With all air vents open, run system circulating pump for a minimum of 30 minutes with the boiler off.

Open all strainers in the circulating system and check for debris.  
Check liquid level in expansion tank. With system full of water at 15 PSIG, the level of water in the expansion tank should not exceed ¼ of the total volume with the balance filled with air.

Start up boiler following instructions provided. Operate entire system including pumps and radiation for at least 1 hour.

Check water level in expansion tank. If level exceeds ½ of tank volume, air is still trapped in system. Shut down boiler and continue to run pumps.

Within 3 days of start up, recheck all air vents and expansion tank as described above.

## 12. MICOFLAME CONTROL PANEL

This controller accommodates up to four-stage control with six modes of operation which provides setpoint as well as rest control. It provides the following:

1. Readings of inlet and outlet water temperatures as well as  $\Delta T$  temperature rise
2. Six pre-set modes of operation; mode 1, 2, 4, and 5 for heating, mode 3 for DHW and mode 6 for operation by a remote controller.
3. Operation as an auto reset limit.
4. Operation as a control for inlet water temperature.
5. Optional tank mounted sensor used in conjunction with inlet sensor.
6. Adjustable pump delay feature based on  $\Delta T$  temperature difference between inlet and outlet temperatures. Accepts 1/6 hp. pump directly across terminals 13 & 14.
7. Adjustable; target temp, inter-stage differential, on delay between stages, minimum on time per stage, minimum off time per stage.
8. Display of run hours for maintenance purposes. Counter wraps around at 1000 hours.
9. Flame failure signal 24 V.
10. Molex connector for ease of service.
11. Error message display.
12. Test override feature to test pump operation, stages 1, 2, 3, and 4 and alarm.
13. Pump exercising feature runs pump 10 seconds every three days of no pump operation.

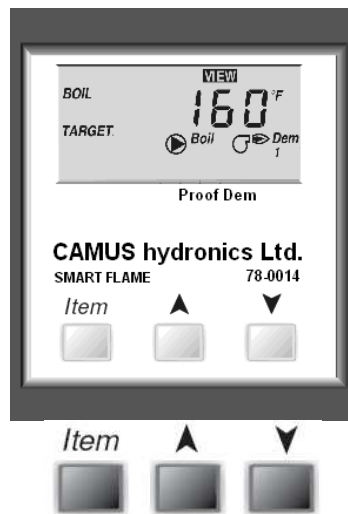

Table 4: BTC 1 Key Functions





KEY	KEY DESCRIPTION
Item	The abbreviated name of the selected item will be displayed in the item field of the display. To view the next item, press the Item button.
▲	Increase a parameter value.
▼	Decrease a parameter value.

### Levels of Access

View – Access to general boiler and display settings and will allow adjustments to the central heating and domestic hot water setpoint.

Adjust – Access to all user parameters and allows for changes to additional boiler parameters to allow for ease of startup and serviceability.

### 12.1 GENERAL SYMBOL DESCRIPTION

SYMBOL	SYMBOL NAME	SYMBOL DESCRIPTION
 <b>Boil</b>	Boiler Pump	Shown when boiler pump is in operation
 <b>DHW</b>	DHW Pump	Shown when DHW pump is in operation
<b>Dem 1</b>	Heat Demand	Shown when heat demand is present
<b>Dem 2</b>	Flame Proof	Shown when flame signal is proven
	Burner	Shown when burner is on
	Warning	Shown when an error is present
	Pointers	Shows the operation as indicated by the text (Proof Dem)
<b>WWSD</b>	WWSD	Displays when the control is in Warm Weather Shutdown

## 12.2 MODE 1 & 2: SETPOINT OPERATION: VIEW DISPLAY

**Mode 1** intended for hydronic heating. The set-point for inlet water control is pre-set to 180°F and the auto re-set limit is set to 230°F. The inlet set-point can be adjusted, however the limit is fixed. In addition to the auto reset limit the factory installs a manual re-set limit set to 250°F. The control turns on the appliance pump and stages the appliance to maintain set-point target temperature at the **appliance inlet** temperature whenever an external heat demand is present. Once the external heat demand is removed, the control turns off the appliance and operates the appliance pump based on

**Mode 2** is intended for hydronic heating. The set-point for inlet water control is pre-set to 180°F and the auto re-set limit is set to 230°F. The inlet set-point can be adjusted, however the limit is fixed. In addition to the auto reset limit the factory installs a manual re-set limit set to 250°F. The control turns on the appliance pump and stages the appliance to maintain set-point target temperature at the appliance inlet temperature whenever an external heat demand is present. Once the external heat demand is removed, the control turns off the appliance and operates the appliance pump based on the purge feature. The control turns on the appliance pump and stages the appliance to the set-point target temperature at the **system** temperature whenever an external heat demand is present. Once the last appliance stage turns off and the heat demand is still present, the control then operates the appliance pump based on the purge feature. In this case, it is imperative that the system pump operates continuously in order to provide constant circulation past the system sensor. The appliance pump then turns back on with the first stage of the appliance. If the heat demand is removed, the appliance is turned off and the control operates the appliance pump P1 based on the purge feature.

From the Home display;







- 1) Press [ITEM] to view the following parameters:

Display	Parameter Name	Parameter Description	Parameter Range
	Boiler System Temperature (Mode 2 ONLY)	Real-time System Temperature to Boiler	14 to 266°F (-10 to 130°C)
	Boiler Outlet Temperature	Real-time Outlet Temperature to Boiler	14 to 266°F (-10 to 130°C)
	Boiler Inlet Temperature	Real-time Inlet Temperature to Boiler	14 to 266°F (-10 to 130°C)
	Boiler Delta T	Real-time temperature difference between the outlet sensor and the inlet sensor.	-99 to 252°F (-72 to 140°C)
	Total Run Time Since Installation	Monitors the amount of operational time since the Unit was installed. The first two digits are the number of thousands of hours and the three digit display shows the number of hundreds of hours. Press (▲, ▼) simultaneously to reset the counter	Alternates between 00 and 999

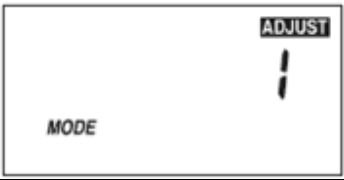
### 12.3 MODE 1 & 2: SETPOINT OPERATION: ADJUST DISPLAY

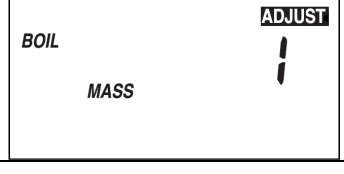
From the Home display;

1) Press (Item, ▲, ▼) simultaneously to view the following parameters:





Display	Parameter Name	Parameter Description	Parameter Range
	Mode	Operating mode for the boiler.  <b>NOTE:</b> A complete description of each mode can be found in section 8.4 Modes of Operation in this manual.	1 to 6  Default = 1
	Boiler Target Temperature	To provide a target setpoint for the heating system. Setpoint is controlled to the inlet sensor	70 to 220°F (21 to 104°C)  Default = 120°F (49°C)
	Boil Mass (Mode 2 ONLY)	Thermal mass of boiler. This determines interstage delay and minimum on and minimum off times.	1 to 3  Default = 1
	Differential Temperature	To provide a modulation rate above and below the Boiler Target temperature. For example, if the value is 10°F and the Boiler Target is 160°F the boiler will begin to modulate at 150°F and shut off at 170°F.	Au, 2 to 42°F (Au, -17 to 6°C)  Default = 10°F
	Pump Delay	Boiler post pump time after burner has shut off, in seconds.	OFF, 0:20 to 9:55 min, On  Default = 1:00 min
	Temperature Units	Select the desired unit of measurement	°F, °C  Default = °F

## 12.4 MODE 3: SETPOINT OPERATION: VIEW DISPLAY

**Mode 3** is intended for domestic water heating. The set-point for inlet water control is pre-set to 140°F and the auto re-set limit is set to 200°F. The inlet set-point can be adjusted, however the limit is fixed. In addition to the auto reset limit the factory installs a manual re-set limit set to 210°F. The control turns on the appliance pump and stages the appliance to maintain set-point target temperature at the **appliance** inlet temperature. An internal demand is generated from the DHW sensor which could be placed in the storage tank while the external heat demand is permanently wired or through a timer. Once the DHW tank is satisfied (internal demand is removed), the control turns off the appliance and operates the appliance pump based on the purge feature.

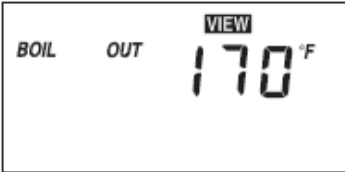
From the Home display;

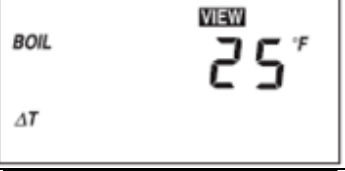

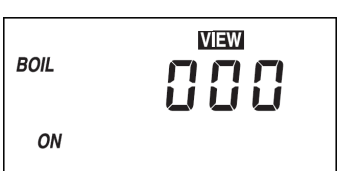
- 1) Press **[ITEM]** to view the following parameters:

Display	Parameter Name	Parameter Description	Parameter Range
	Boiler Outlet Temperature	Real-time Outlet Temperature to Boiler	14 to 266°F (-10 to 130°C)
	Boiler Inlet Temperature	Real-time Inlet Temperature to Boiler	14 to 266°F (-10 to 130°C)
	Boiler Delta T	Real-time temperature difference between the outlet sensor and the inlet sensor.	-99 to 252°F (-72 to 140°C)
	Tank Temperature	Real-time Tank Temperature to Boiler	14 to 266°F (-10 to 130°C)
	Total Run Time Since Installation	Monitors the amount of operational time since the unit was installed. The first two digits are the number of thousands of hours and the three digit display shows the number of hundreds of hours. Press (▲ ▼) simultaneously to reset the counter	Alternates between 00 and 999

**12.5 MODE 3: SETPOINT OPERATION: ADJUST DISPLAY**

From the Home display;

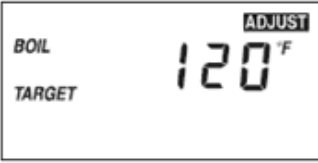
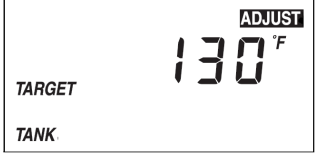
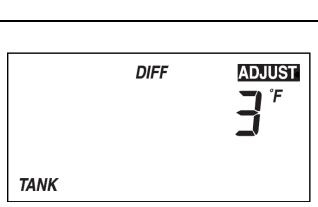
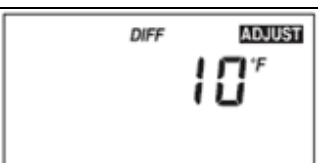
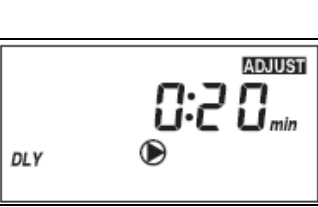
- 1) Press (Item, ▲, ▼) simultaneously to view the following parameters:

Display	Parameter Name	Parameter Description	Parameter Range
	Mode	Operating mode for the boiler. <b>NOTE:</b> A complete description of each mode can be found in section 8.4 Modes of Operation in this manual.	1 to 6 Default = 1
	Boiler Target Temperature	To provide a target setpoint for the heating system. Setpoint is controlled to the inlet sensor	OFF, 70 to 220°F (OFF, 21 to 104°C) Default = 140°F (82°C)
	Tank Target Temperature	To provide a target setpoint for the Tank. Setpoint is controlled to the Tank sensor	OFF, 70 to 190°F (OFF, 21 to 88°C) Default = 130°F (54°C)
	Tank Differential	To provide a modulation rate above and below the Tank Target Temperature. For example, if the value is 10°F and the Tank Target Temperature is 160°F the boiler will begin to modulate at 150°F and shut off at 170°F.	2 to 10°F (1 to 5°C) Default = 3°F (1°C)
	Differential Temperature	To provide a modulation rate above and below the Boiler Target temperature. For example, if the value is 10°F and the Boiler Target is 160°F the boiler will begin to modulate at 150°F and shut off at 170°F.	Au, 2 to 42°F (Au, -17 to 5°C) Default = 10°F
	Pump Delay	Boiler post pump time after burner has shut off, in seconds.	OFF, 0:20 to 9:55 min, On Default = 1:00 min
	Temperature Units	Select the desired unit of measurement	°F, °C Default = °F



## 12.6 MODE 4 & 5: OUTDOOR RESET OPERATION: VIEW DISPLAY

**Mode 4** is intended for hydronic heating. The set-point for inlet water control is pre-set to 180°F and the auto re-set limit is set to 230°F. The inlet set-point can be adjusted, however the limit is fixed. In addition to the auto reset limit the factory installs a manual re-set limit set to 250°F. The control turns on the appliance pump and stages the appliance to maintain outdoor reset target temperature at the **appliance** inlet temperature whenever an external heat demand is present. Once the external heat demand is removed, the control turns off the appliance and operates the appliance pump based on the purge feature.

**Mode 5** is intended for hydronic heating. The set-point for inlet water control is pre-set to 180°F and the auto re-set limit is set to 230°F. The inlet set-point can be adjusted, however the limit is fixed. In addition to the auto reset limit the factory installs a manual re-set limit set to 250°F. The control turns on the appliance pump and stages the appliance to maintain outdoor reset target temperature at the **system** temperature whenever an external heat demand is present. Once the last appliance stage turns off and the heat demand is still present, the control then operates the appliance pump based on the purge feature. In this case, it is imperative that the system pump operates continuously in order to provide constant circulation past the system sensor. The appliance pump then turns back on with the first stage of the appliance. If the heat demand is removed, the appliance is turned off and the control operates the appliance

From the Home display;

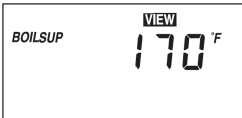
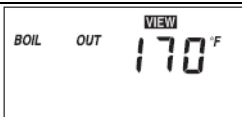

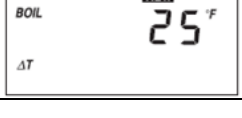
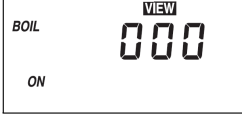

- 1) Press **[ITEM]** to view the following parameters:



Display	Parameter Name	Parameter Description	Parameter Range
	Outdoor Temperature	Real-time Outdoor Temperature	-60 to 190°F (-51 to 88°C)
	Boiler System Temperature (Mode 5 ONLY)	Real-time System Temperature to Boiler	14 to 266°F (-10 to 130°C)
	Boiler Outlet Temperature	Real-time Outlet Temperature to Boiler	14 to 266°F (-10 to 130°C)
	Boiler Inlet Temperature	Real-time Inlet Temperature to Boiler	14 to 266°F (-10 to 130°C)
	Boiler Delta T	Real-time temperature difference between the outlet sensor and the inlet sensor.	-99 to 252°F (-72 to 140°C)
	Total Run Time Since Installation	Monitors the amount of operational time since the unit was installed. The first two digits are the number of thousands of hours and the three digit display shows the number of hundreds of hours. Press (▲, ▼) simultaneously to reset the counter	Alternates between 00 and 999

## 12.7 MODE 4 & 5: OUTDOOR RESET OPERATION: ADJUST DISPLAY

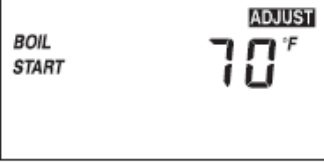
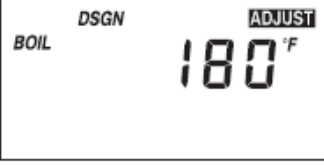
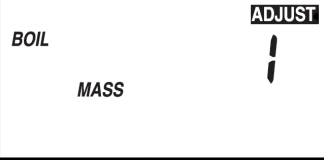
From the Home display;

- 1) Press (Item, ▲, ▼) simultaneously to view the following parameters:



Display	Parameter Name	Parameter Description	Parameter Range
	Mode	Operating mode for the boiler. <b>NOTE:</b> A complete description of each mode can be found in section 8.4 Modes of Operation in this manual.	1 to 6 Default = 1
	Outdoor Start Temperature	Outdoor starting temperature used in the reset ratio for the heating system. Typically set to the desired building temperature.	35 to 85°F (2 to 29°C) Default = 60°F (21°C)
	Outdoor Design Temperature	Outdoor design temperature used in the reset ratio for the heating system. Set to the coldest annual outdoor temperature in the local area.	-60 to 50°F (-51 to 10°C) Default = -10°F (-23°C)
	Boiler Start Temperature	Starting water temperature used in the reset ratio calculation for the heating system. Typically set to the desired building temperature.	35 to 150°F (2 to 66°C) Default = 70°F (21°C)
	Boiler Design Temperature	Boiler design water temperature used in the reset ratio calculation for the heating system. Set to the boiler water temperature required to heat the building on the coldest annual outdoor temperature.	70 to 230°F (21 to 110°C) Default = 180°F (82°C)
	Boil Mass (Mode 5 ONLY)	Thermal mass of boiler. This determines interstage delay and minimum on and minimum off times.	1 to 3 Default = 1
	Differential Temperature	To provide a modulation rate above and below the Boiler Target temperature. For example, if the value is 10°F and the Boiler Target is 160°F the boiler will begin to modulate at 150°F and shut off at 170°F.	Au, 2 to 42°F (Au, -16 to 5°C) Default = 10°F

	Pump Delay	Boiler post pump time after burner has shut off, in seconds.	OFF, 0:20 to 9:55 min, On Default = 1:00 min
	Warm Weather Shutdown Temperature	Warm weather shutdown temperature using outdoor reset.	35 to 105°F, OFF (2 to 41°C, OFF) Default = 0:20 min
	Temperature Units	Select the desired unit of measurement	°F, °C Default = °F

**12.8 MODE 6: OUTDOOR RESET OPERATION: VIEW DISPLAY**

**Mode 6** is intended for multiple appliance application and all stages are closed at all times. In essence there is no operator at the appliance. A removable jumper is provided in the electrical enclosure across the contacts to be used for connection to the remote operator. The fixed auto re-set limit is set to 230°F . In addition to the auto reset limit the factory installs a manual re-set limit set to 250°F. The control provides pump operation. Staging operation is provided by an external sequencing control. Heat demand is provided to the external sequencing control. External sequencing control then provides heat demand to the control. Each control turns on its respective appliance pump and stage 1 contact whenever an external heat demand is present. Once the external heat demand is removed from the control, the control turns off the stage 1 contact and operates the pump to provide purging. Once the purge period is complete, the control turns off the appliance pump.

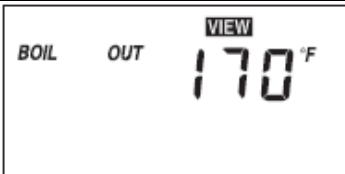
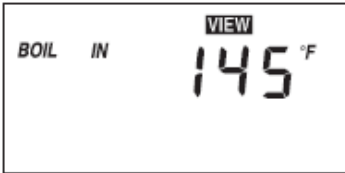

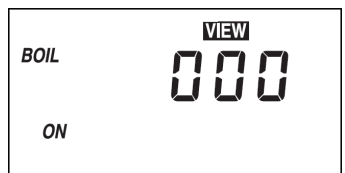
From the Home display;  
the display (ITEM) to view the following parameters:

Display	Parameter Name	Parameter Description	Parameter Range
	Boiler Outlet Temperature	Real-time Outlet Temperature to Boiler	14 to 266°F (-10 to 130°C)
	Boiler Inlet Temperature	Real-time Inlet Temperature to Boiler	14 to 266°F (-10 to 130°C)
	Boiler Delta T	Real-time temperature difference between the outlet sensor and the inlet sensor.	-99 to 252°F (-72 to 140°C)
	Total Run Time Since Installation	Monitors the amount of operational time since the unit was installed. The first two digits are the number of thousands of hours and the three digit display shows the number of hundreds of hours. Press (▲ ▼) simultaneously to reset the counter	Alternates between 00 and 999

**12.9 MODE 6: OUTDOOR RESET OPERATION: ADJUST DISPLAY**

From the Home display;

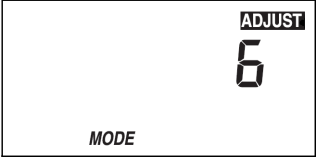
- 1) Press (Item, ▲, ▼) simultaneously to view the following parameters:

Display	Parameter Name	Parameter Description	Parameter Range
	Mode	Operating mode for the boiler. <b>NOTE:</b> A complete description of each mode can be found in section 8.4 Modes of Operation in this manual.	1 to 6 Default = 1
	Pump Delay	Boiler post pump time after burner has shut off, in seconds.	OFF, 0:20 to 9:55 min, On Default = 1:00 min
	Temperature Units	Select the desired unit of measurement	°F, °C Default = °F

**13. IGNITION SYSTEM SAFETY SHUT-OFF DEVICE**

After initial fill while the main burner is firing, shut off gas to the pilot and clock the time taken for the main gas valve to shut down. If the safety control is functioning properly, power to the gas valve will be shut off within 4 seconds of the pilot gas being shut off. If shut down takes longer, ignition control or gas valve may be defective.

**14. LOW WATER TEMPERATURE SYSTEMS**

In applications where the heating system requires supply water temperatures below 110°F, a bypass line must be installed upstream of the boiler pump so that outlet water can be re-circulated to raise the inlet temp to a minimum of 110°F. Balancing valves, preferably globe valves are used to adjust flow. (See Figure 5)

Figure 5

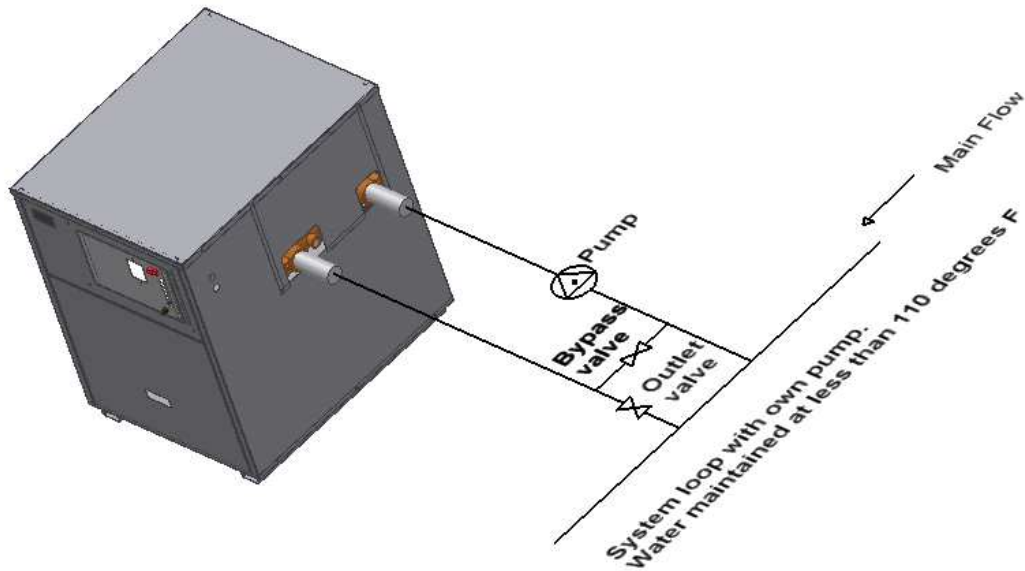

- Adjustment procedure.
  - a. Fully open bypass and outlet valves.
  - b. With boiler running, read inlet temperature after 15 minutes.
  - c. If the inlet temperature is less than 115°F (46 °C) slowly close outlet valve until the inlet temperature climbs to 115°F (46 °C)
  - d. If the inlet temperature is greater than 115°F (46°C) but not greater than 140 °F no further adjustment is required.
  - e. Check the inlet temperature after 5 minutes and make final adjustments.

## 15. INSTANTANEOUS WATER HEATER

An instantaneous water heater is designed to deliver hot water without the use of a storage tank. It is suitable for applications with variable load such as restaurants, condominiums, apartments and motels. (See Figure 6) Call factory for recommendations.

**Figure 6**

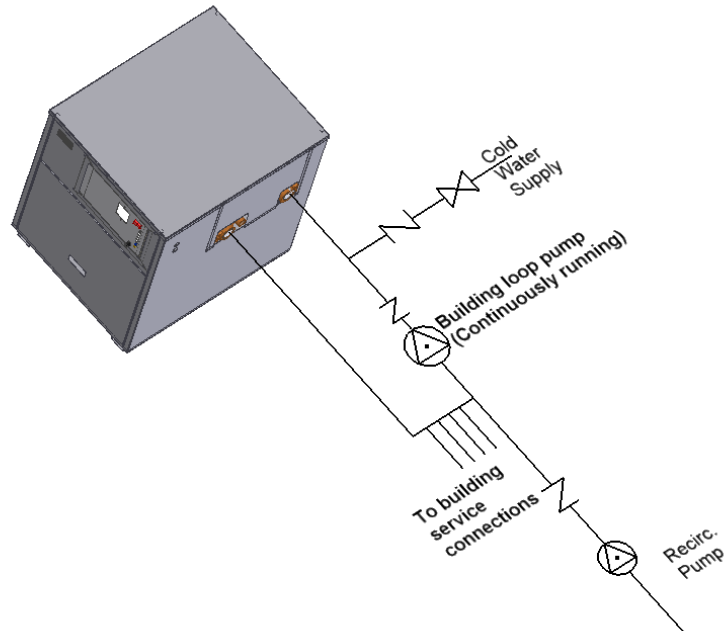

## 16. CONDENSING HEAT RECOVERY MODULE

The MicoFlame could be provided in condensing mode for a variety of application including domestic hot water and hydronic space heating.

The CHRМ is intended to extract total (sensible and latent) heat from the flue gases downstream of the primary heat exchanger. As a result, condensation of moisture in the flue gas will take place on the CHRМ surfaces and in the exhaust vent. This condensation is a natural outcome when efficiencies exceed 90%.

A neutralizer cartridge is provided and must be installed in the line from the condensate collection pot to the drain. PH level of the condensate is to be checked regularly and neutralizing medium is to be replaced as required to maintain effectiveness. A neutralizer cartridge is available from the factory.

Recommended installation methods of the condensing MicoFlame will vary depending on the application and the expected water temperature variation of the system.

Examples of recommended installation for typical applications are shown below:

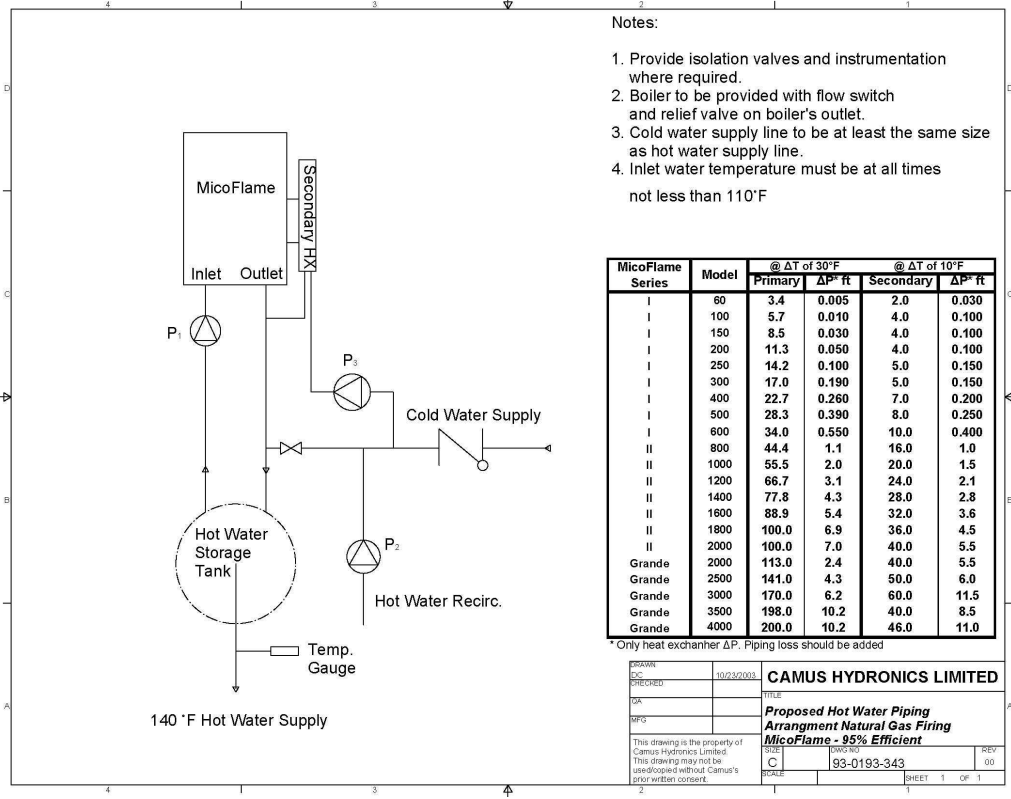
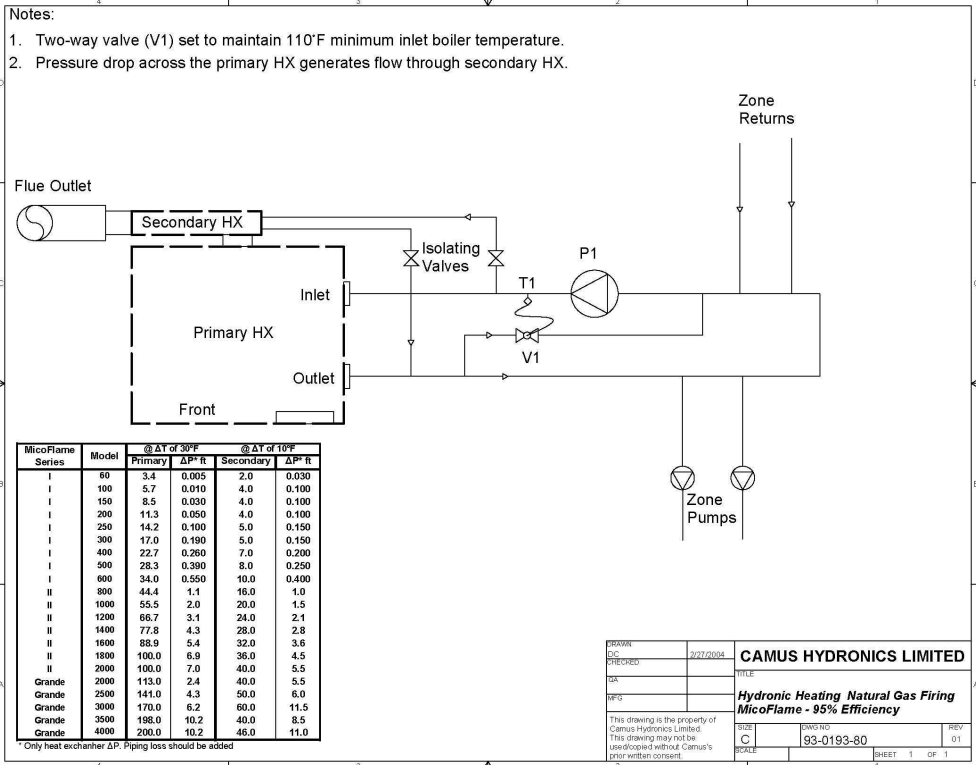

## 17. PILOT AND MAIN BURNER FLAMES

To maintain safe operation and the greatest efficiency of the boiler, check the main burner and pilot burner every six months for proper flame characteristics.

### 17.1. MAIN BURNER

The main burner, Figure 7 should display the following characteristics;

- Acceptable CO and CO<sub>2</sub> levels for complete combustion.
- Light off smoothly.
- Reasonably quiet while running.
- Stable flame with minimum of lifting.
- Blue flame with natural gas, yellow tips with propane gas

**Figure 7**

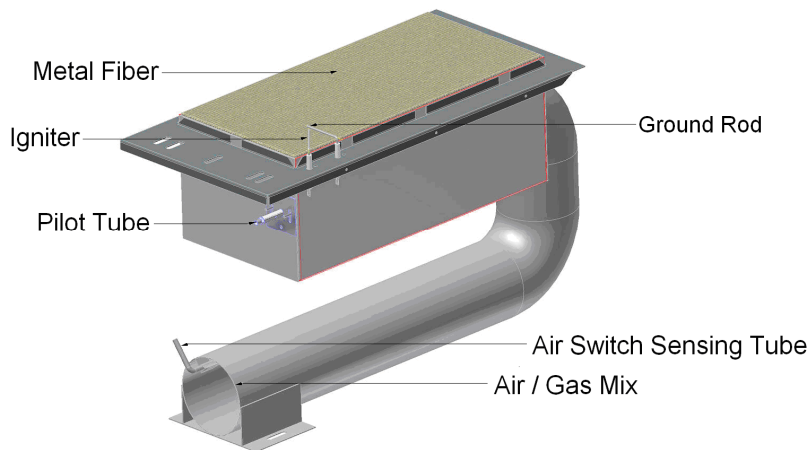

If burner characteristics do not match the above, check for proper air box pressure. Also look for accumulation of lint and other foreign material at fan air inlets. Typical air box settings are as follows:

MODEL	AIR BOX " W.C. (with burner firing)	FLUE SWITCH RECYCLE POINT " W.C
060	0.20	0.15
100	0.25	0.20
150	0.30	0.25
200	0.35	0.30
250	0.38	0.33
300	0.40	0.35
400	0.52	0.42
500	0.60	0.48
600	0.70	0.58

Depending on field conditions air box pressures will have to be adjusted accordingly. Always set the appliance for a CO<sub>2</sub> level in the range of 7.5% to 8.0 % for non-condensing appliances and 8.5% to 9.0% for condensing appliances. For propane fired appliances the setting will be approximately 1.5% higher.

A qualified service technician should follow this procedure when burner needs cleaning.

1. Shut off power and close main manual gas valve.
  - Allow burner to cool before removal.
2. Remove access cover screws.
  - Disconnect pilot gas at bulkhead fitting.
  - Disconnect ground wire and ignition wire.
  - Remove two wing nuts holding down burner.
  - Gently pull down and forward to disengage burner.
  - Remove burner being careful to not damage the igniter or ground electrodes.
3. Thoroughly clean burner. Check all ports and air channels for blockage.
4. Reinstall the burner being careful to fully engage the back of the burner box into the retaining slot in the combustion chamber base. Failure to properly locate the burner will result in erratic flame operation with the possibility of delayed ignition on light off.
5. Restore electrical power and gas supply to the boiler.
  - Following the lighting instructions put the boiler back into operation
  - Check for gas leaks and proper boiler and vent operation.

## 17.2 REMOVAL OF COMBUSTION CHAMBER LINING

The combustion chamber insulation in this appliance contains ceramic fiber material. Ceramic fibers can be converted to cristobalite in very high temperature applications. The International Agency for Research on Cancer (IARC) has concluded, "Crystalline silica in this form of quartz of cristobalite from occupational sources is carcinogenic to humans (Group 1)". Normal operating temperatures in this appliance are below the level to convert ceramic fibers to cristobalite. Abnormal operating conditions would have to be created to convert the ceramic fibers in this appliance to cristobalite.

The ceramic fiber material used in this appliance is an irritant; when handling or replacing the ceramic materials it is advisable that the installer follow these safety guidelines.

- Avoid breathing dust and contact with skin and eyes.
  - Use NIOSH certified dust respirator (N95). This type of respirator is based on the OSHA requirements for cristobalite at the time this documentation was written. Other types of respirators may be needed depending on the job site conditions. Current NIOSH recommendations can be found on the NIOSH website at <http://www.cdc.gov/niosh/homepage.html>. NIOSH approved respirators, manufacturers, and phone numbers are also listed on this website.
  - Wear long-sleeved, loose fitting clothing, gloves, and eye protection
- Apply enough water to the combustion chamber lining to prevent airborne dust.
- Remove the combustion chamber lining from the water heater and place it in a plastic bag for disposal.
- Wash potentially contaminated clothes separately from other clothing. Rinse clothes washer thoroughly.

### **NIOSH stated First Aid**

- Eye: Irrigate immediately
- Breathing: Fresh air

### 17.3 PILOT BURNER

Turn the pilot firing valve to off position and allow the appliance to try for ignition. Observe the spark making sure that it is strong and continuous.

If the spark is not acceptable the igniter will have to be adjusted. This can be readily accomplished after removing the main burner.

The spark gap should be 1/8" to 3/16". Make sure that the electrode does not appear overheated or fouled with carbon. It may be necessary to clean the ignition electrode using steel wool. Once the pilot appears to be properly set, reinstall it into the appliance making sure to properly tighten the pilot line connection.

If the pilot is removed from the main burner in the course of servicing the appliance, it is important to reinstall it so that there is no gap between the top surface of the pilot tube and the underside of the metal filter support screen. When properly set it will not be possible to slip a business card between the pilot burner and the support screen. Figure 8 shows the burner box assembly with the metal filter cover removed to expose pilot tube.

**Figure 8**

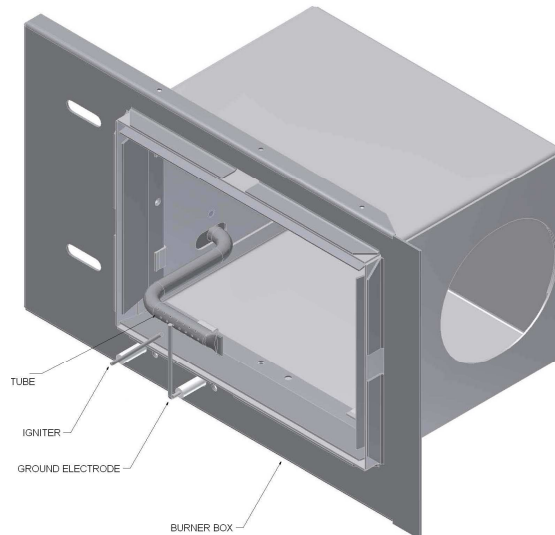

Once the spark is satisfactory, open the pilot gas and allow the pilot burner to light. Once air has been purged from the pilot line, the pilot flame should appear almost instantly at the initiation of spark. Cycle the pilot several times to confirm reliability. A properly set pilot will appear blue and will engulf the igniter and ground electrode.

Open the firing valve and allow the main burner to light. The pilot must not extinguish. After running for 15 minutes, cycle the appliance to ensure that the pilot remains stable.

## **18. OPERATION AND SERVICE**

### **OPERATION:**

Before operating the boiler, the entire system must be filled with water, purged of air and checked for leaks. Do not use Stop leak or other boiler compounds. The gas piping must also be leak tested.

Any safety devices including low water cutoff, flow switch and high limit used in with this boiler must receive periodic inspection (every six months) to assure proper operation. A low water cutoff of the float type should be flushed every six months. All relief valves should be inspected and manually operated every six months.

For your safety follow the lighting and operating instructions below and on the boiler.

To turn on main burner, slowly open firing valve after pilot is established.

Set primary system controller to desired temperature.

To turn off boiler close main manual gas valve, close pilot manual valve and turn off electric power to system.

## SERVICE:

Disconnect main power and turn off gas supply before servicing unit.

To remove and clean the burner, follow the detailed procedure in section 17 of this manual

After the first season of operation inspect the heat exchanger and venting. Follow the detailed instructions in section 6 of this manual.

**CAUTION:** Label all wires prior to disconnection when servicing controls. Wiring errors can cause improper and dangerous operation. Verify proper operation after servicing.

Any audible sounds in the equipment, like pinging, crackling or hissing are indications of scaling or lack of sufficient water flow. Under these conditions the boiler must be shut down immediately and the heat exchanger checked for damage. If the exchanger is damaged from scaling, it is not covered by warranty.

Should your equipment be subjected to fire, flood or some other unusual condition, turn off all gas and electrical supply. If you are unable to turn off the gas, call your gas company or gas supplier at once. Do not put the unit back in operation until it has been checked by a qualified agency to ensure that all controls are functioning properly.

Units that are not operated for a period of 60 days or more are considered seasonal operations. It is recommended that before returning one of these units to service, the proper operation of all controls be checked by a qualified service technician.

## 19. LIGHTING INSTRUCTIONS

1. Turn off electric power to boiler.
2. Close main manual valve and main firing valve and wait 5 minutes.
3. Set primary system controller to desired temperature.
4. Open pilot valve.
5. Turn on electric power to boiler. The electrode at the pilot should begin to spark after pre-purge is complete. The pilot valve will open to permit gas flow to the pilot.
6. There is a 15 second trial for ignition, which is enough time to light the pilot if air is not present in the pilot line. If pilot fails to light and you suspect air in the line, close the main manual valve and repeat lighting steps 1 thru 5.
7. Once the pilot lights, it should envelope the ignition rod and ground electrode. The pilot can be adjusted by removing the pilot regulator cover and turning the adjustment screw counterclockwise to decrease it or clockwise to increase it.
8. Open the main manual and main firing valves to allow gas to reach the main burner. If the main burner fails to ignite, turn the firing valve off and check to see that the pilot is burning. If not, repeat lighting procedure steps 1 thru 7.

**TO TURN OFF BOILER:** Close main manual valve and main firing valve and turn off electric power to system.

## 20. TROUBLE SHOOTING GUIDE

SYMPTOM	SOLUTION
1. Power light is not lit when switch is flipped to "ON"	<ul style="list-style-type: none"> <li>• Check wiring to switch.</li> <li>• Check circuit breaker.</li> <li>• Check fuse.</li> </ul>
2. Water flow light remains off.	<ul style="list-style-type: none"> <li>• Verify that pump is running.</li> <li>• Check wiring to flow switch.</li> </ul>
3. Pilot sparks but does not light	<ul style="list-style-type: none"> <li>• Verify that main manual valve is open.</li> <li>• Follow lighting instructions to bleed air out of pilot line.</li> <li>• Remove main burner and inspect for moisture or dirt in pilot or in pilot line.</li> <li>• Verify that pilot is sealed to main burner base.</li> <li>• Verify that gas connections are tight.</li> </ul>
4. Pilot lights momentarily, goes out and then sparks again repeatedly	<ul style="list-style-type: none"> <li>• Observe pilot for proper flame. Adjust if necessary.</li> <li>• Check pilot flame signal. Properly set pilot to generate 1.5 <math>\mu</math>A. D.C. on average.</li> <li>• Remove main burner and ensure that igniter and ground electrodes are positioned properly. Clean with steel wool if necessary.</li> <li>• Verify that back of burner box is fully engaged into the retaining slot in the combustion chamber base.</li> </ul>
5. Pilot lights but main burner does not fire.	<ul style="list-style-type: none"> <li>• Verify that high limit is set high enough to prevent short cycling.</li> <li>• Check pilot flame signal (<math>\mu</math>A).</li> <li>• Adjust pilot pressure for steady flame</li> <li>• Remove main burner. Check position of igniter and ground electrode. Clean with steel wool if necessary.</li> </ul>
6. Main burner lights but cycles off after a few minutes	<ul style="list-style-type: none"> <li>• Verify that high limit is set high enough to prevent short cycling.</li> <li>• Adjust pilot pressure for steady flame</li> <li>• Remove main burner. Adjust pilot shield and clean ignition sensor.</li> </ul>
7. Boiler starts to whine as the temperature rise increases.	<ul style="list-style-type: none"> <li>• Verify that all air is bled from system.</li> <li>• Verify that the static pressure in cold system is at least 15 psig.</li> <li>• Check temperature rise across boiler to ensure adequate water flow.</li> <li>• If necessary, increase static water pressure and decrease gas pressure.</li> </ul>

## 21. TYPICAL GAS TRAIN

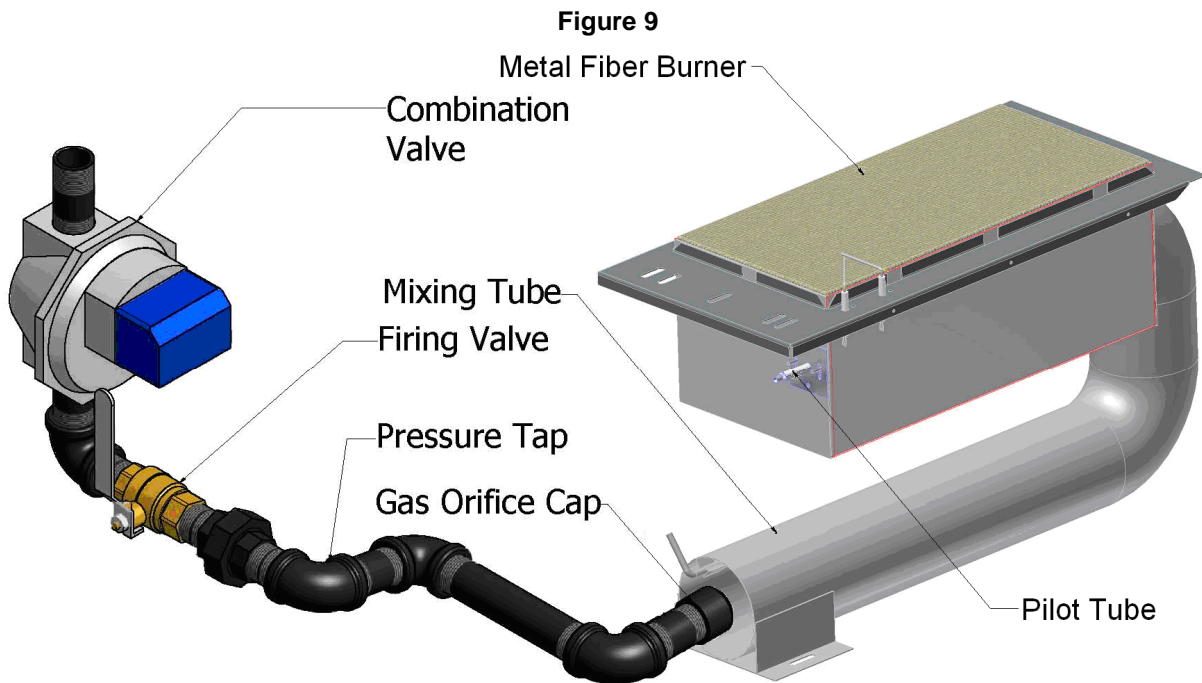

## 22. ELECTRICAL DIAGRAMS

Each MicoFlame boiler will be provided with its own wiring diagram to guarantee that any options ordered with the unit are properly detailed.

The following diagram 99-5060 is provided as a typical sample only.



23. EXPLODED VIEW

MicoFlame  
Exploded View

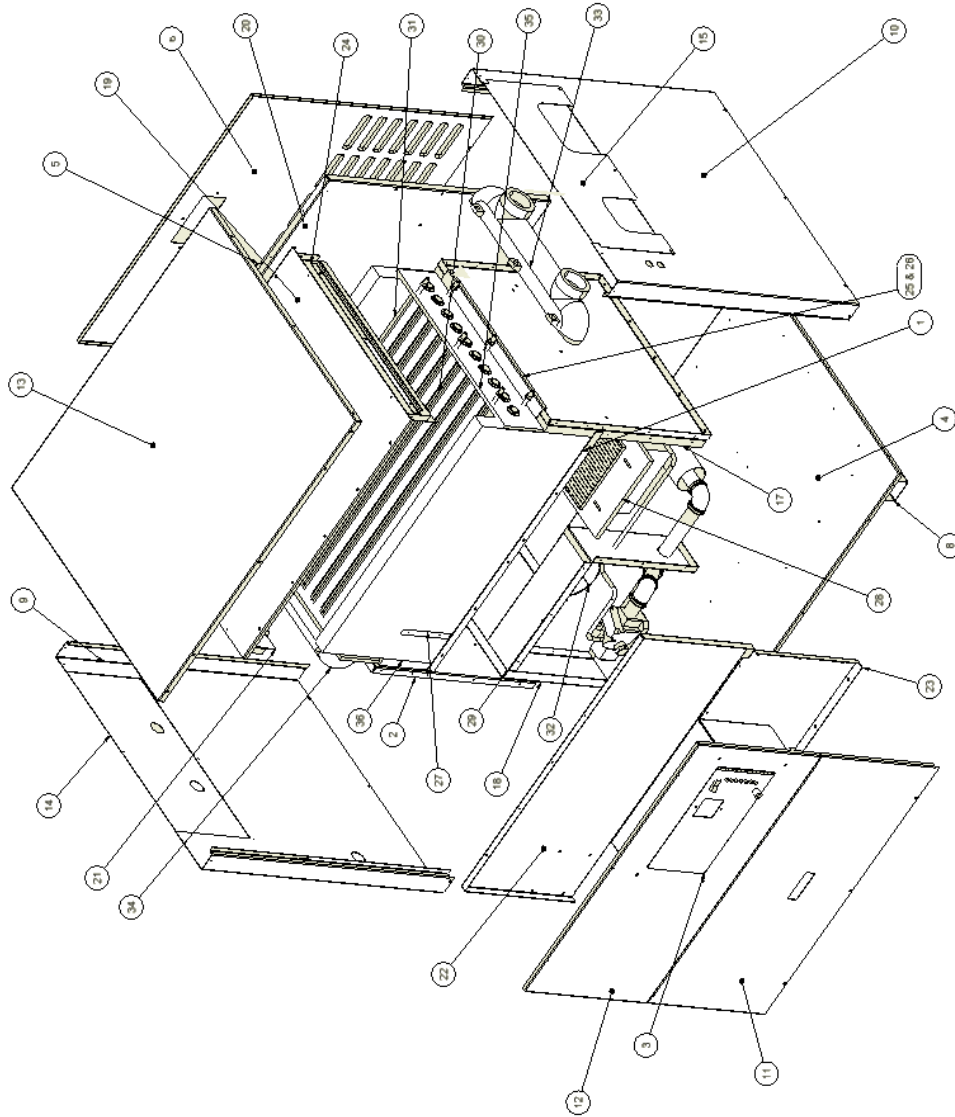

## 24. MICO FLAME REPLACEMENT PARTS LIST

Part	Part Name	60	100	150	200	250	300	400	500	600
1	COMBUSTION CHAMBER BASE PANEL	14-4D75				14-4D55		14-4D05-01		14-4005-03
2	COMBUSTION CHAMBER COMMON END PANEL	14-4D51						14-4D01		
3	CONTROL BOX ASSEMBLY	14-4D28								
4	BASE PANEL	14-4D59-01				14-4D59-05		14-4D09-01		14-4009-03
5	FLUE COLLECTOR OUTLET	14-4D70	2 REQD PER UNIT					14-4D20	2 PER UNIT	
6	OUTER BACK	14-4D61-01				14-4D61-05		14-4D11-01		14-4011-03
7	HEADER BAR SEAL	14-4D22-01						14-4D22-02		
8	LEG	14-4D14	2 REQD PER UNIT							
9	OUTER JACKET LEFT	14-4D82						14-4D32		
10	OUTER JACKET RIGHT	14-4D81						14-4D31		
11	OUTER FRONT LOWER	14-4D62-01				14-4D62-05		14-4D12-01		14-4012-03
12	OUTER FRONT UPPER	14-4D63-01				14-4D63-05		14-4D13-01		14-4013-03
13	TOP COVER	14-4D60-01				14-4D60-05		14-4D10-01		14-4010-03
14	RETURN SIDE ACCESS PANEL	14-4D67						14-4D17		
15	INLET-OUTLET ACCESS PANEL	14-4D66						14-4D16		
16	STIFFENERS	NOT REQUIRED						14-4D15-01		14-4015-02
17	COMBUSTION CHAMBER SUPPORT RIGHT	14-4D53						14-4D03		
18	COMBUSTION CHAMBER SUPPORT LEFT	14-4D54						14-4D04		
19	FLUE COLLECTOR TOP	14-4D57-01			14-4D57-04	14-4D57-05	14-4D57-06	14-4D07-01		14-4007-03
20	COMBUSTION CHAMBER REAR PANEL	14-4D72				14-4D52		14-4D02-01		14-4002-03
21	FLUE COLLECTOR END BRACKET	14-4D58	2 REQD PER UNIT					14-4D08		
22	COMBUSTION CHAMBER UPPER FRONT PANEL	14-4D76				14-4D56		14-4D06-01		14-4006-03
23	BURNER DRAWER DOOR	14-4D80-01				14-4D80-05		14-4D40		
24	HEAT EXCHANGER HEADER BAR STOP	14-4D38-01						14-4D38-02		
25	HEAT EXCHANGER SUPPORT BRKT	14-4D35-01						14-4D35-02		
26	HEAT EXCHANGER SUPPORT BRKT STOP	14-4D36-01						14-4D36-02		
27	HX SUPPORT - LEFT	14-4D71			NONE		NONE	14-4D23		NONE
28	BURNER BOX ASSEMBLY	14-4D79						14-4D29		
29	FAN MOUNTING SUPPORT	NOT REQUIRED						14-4D39-01		14-4039-03
30	HEAT EXCHANGER V BAFFLES	14-4D41-01	14-4D41-02	14-4D41-03	14-4D41-04	14-4D41-05	14-4D41-06	14-4D41-07	14-4D41-08	14-4041-09
31	HEAT EXCHANGER FRONT & REAR BAFFLES	14-4D42-01	14-4D42-02	14-4D42-03	14-4D42-04	14-4D42-05	14-4D42-06	14-4D42-07	14-4D42-08	14-4042-09
32	BLOWER ASSEMBLY	55-0008								
33	INLET / OUTLET HEADER	13-0110								
34	RETURN HEADER	13-0111								
35	HEADER BAR	14-4156								
36	REFRACTORY SET	17-0070-01	17-0070-02	17-0070-03	17-0070-04	17-0070-05	17-0070-06	17-0070-07	17-0070-08	17-0070-09

## WARRANTY

### GENERAL

Camus Hydronics Limited ("Camus"), extends the following LIMITED WARRANTY to the owner of this appliance, provided that the product has been installed and operated in accordance with the Installation Manual provided with the equipment. Camus will furnish a replacement for, or at Camus option repair, any part that within the period specified below, shall fail in normal use and service at its original installation location due to any defect in workmanship, material or design. The repaired or replacement part will be warranted for only the unexpired portion of the original warranty. This warranty does not cover failures or malfunctions resulting from: (1) Failure to properly install, operate or maintain the equipment in accordance with Camus' manual; (2) Abuse, alteration, accident, fire, flood, foundation problems and the like; (3) Sediment or lime buildup, freezing, or other conditions causing inadequate water circulation; (4) Pitting and erosion caused by high water velocity; (5) Failure of connected systems devices, such as pump or controller; (6) Use of non-factory authorized accessories or other components in conjunction with the system; (7) failing to eliminate air from, or replenish water in, the connected water system; (8) Chemical contamination of combustion air or use of chemical additives to water.

### HEAT EXCHANGER

If within TEN years after initial installation of the appliance, a heat exchanger, shall prove upon examination by Camus to be defective in material or workmanship, Camus will exchange or repair such part or portion on the following pro rated limited warranty. (1) Years one through five - standard warranty (2) Years six through ten - replacement purchase price pro rated at the following schedule: Year six - 60%, Year seven - 65%, Year eight -70%, Year nine -75% Year ten -80% of the current list price of the current list price This term is reduced to FIVE years if the appliance is used for other than hydronic space heating.

Heat Exchanger shall be warranted for (20) years from date of installation against "Thermal Shock" (excluded, however, if caused by appliance operation at large changes exceeding 150 °F between the water temperature at intake and appliance temperature, or operating at appliance temperatures exceeding 230 °F).

### BURNER

If within FIVE years after initial installation of the appliance a burner shall prove upon examination by Camus to be defective in material or workmanship, Camus will exchange or repair such part or portion.

### ANY OTHER PART

If any other part fails within one (1) year after installation, or eighteen (18) months from date of factory shipment based on Camus' records, whichever comes first. Camus will furnish a replacement or repair that part. Replacement parts will be shipped f.o.b. our factory.

### HOW TO MAKE A CLAIM

Any claim under this warranty shall be made directly to Camus Hydronics Limited Canadian Head Office

### SERVICE LABOR RESPONSIBILITY

Camus shall not be responsible for any labour expenses to service, repair or replace the components supplied. Such costs are the responsibility of the owner.

### DISCLAIMERS

Camus shall not be responsible for any water damage. Provisions should be made that in the event of a water/appliance or fitting leak, the resulting flow of water will not cause damage to its surroundings.

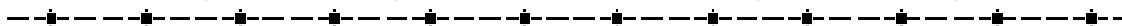

Name of Owner \_\_\_\_\_ Name of Dealer \_\_\_\_\_

Address \_\_\_\_\_ Address \_\_\_\_\_

\_\_\_\_\_

Model No. \_\_\_\_\_ Serial No. \_\_\_\_\_

Date of Installation: \_\_\_\_\_ Date of Initial Operation: \_\_\_\_\_

[6226 Netherhart Road, Mississauga, Ontario, L5T 1B7, CANADA](#)



**CAMUS Hydronics is a manufacturer of replacement parts for most copper finned water heaters and heating boilers as well as a**



**supplier of specialty HVAC products. Our service line is open 24 hours, 7 days a week!**

**The CAMUS CERTIFIED! Seal assures you that Reliability, Efficiency & serviceability are built into every single unit! For more information**

**on our innovative products from CAMUS Hydronics Limited, call 905-696-7800 today.**



***CAMUS HYDRONICS LTD.***

***6226 Netherhart Road, Mississauga, Ontario L5T 1B7***

***TEL: 905-696-7800 FAX: 905-696-8801***